

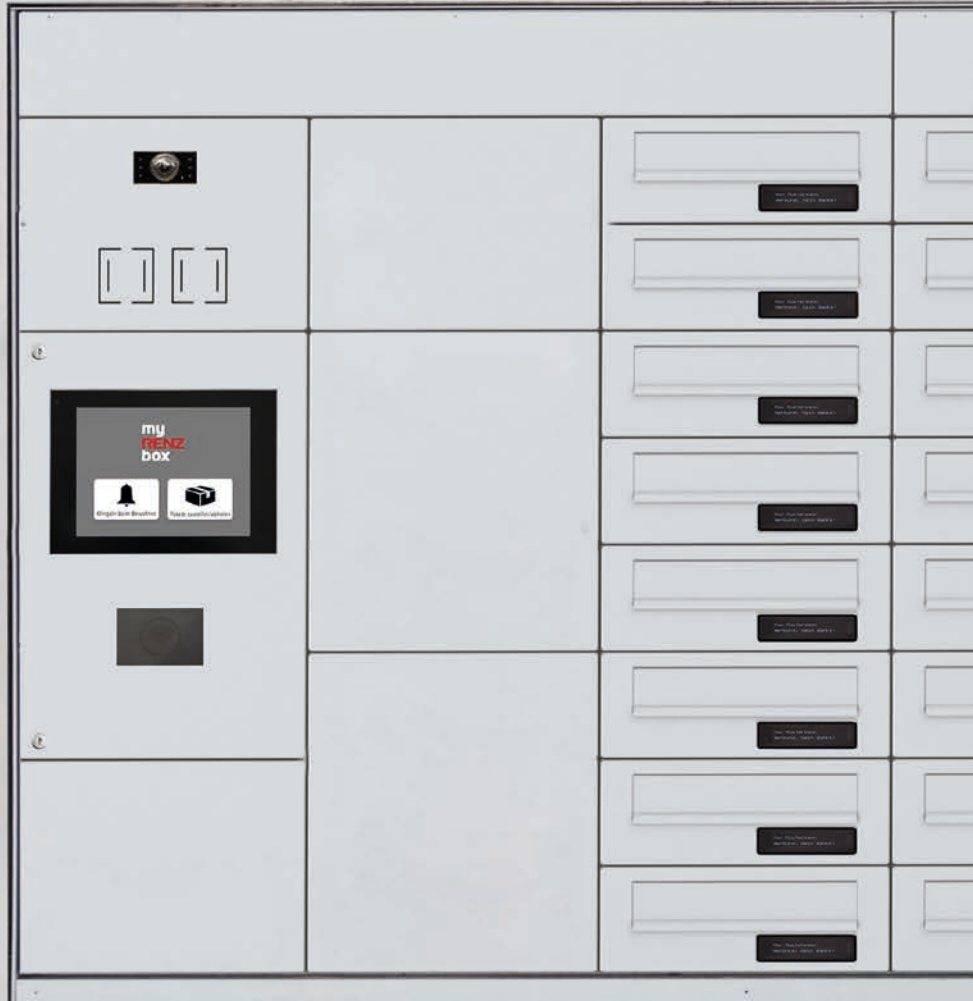

intelligent boxes



## Mail and parcel box units for apartment buildings

August 2023 version  
[www.renzgroup.com](http://www.renzgroup.com)



## Digital management. Intelligent control. Safe receipt.

Dear customers and potential customers,

The topic of digitisation is more important than ever in real estate management. We're the European market leader in mail and parcel box units, so our solutions are therefore highly advanced. Our intelligent boxes enable parcels to be easily received and sent – around the clock and indeed at and from home. Surveys have ultimately revealed that the majority of citizens would prefer to have their parcels delivered to their home, rather than having to collect them from a different location.

Yet a myRENZbox is far more than merely a practical parcel station. When combined with an electronic mailbox and doorbell system, it becomes a digital doorway – an intelligent handover platform for all kinds of letters, goods and services. It is conveniently operated via touch screen, app and online platform – a flexible system solution that optimally networks property managers, residents, delivery drivers and suppliers. Even electronic locking or ERP systems can be integrated without problems.

The tried and tested Renz mechanical mailbox units naturally continue to be an integral part of our range. And like all products supplied by our family business, they meet the same high quality standards which have been familiar for over 90 years.

Our new brochure provides you with a far-reaching overview of the digital and mechanical solutions that Renz has developed for apartment buildings. We hope that you'll enjoy browsing through it – and we're confident that it will also contain the right solution for your building.

With warm regards  
Armin Renz, Managing Director

We see the future as requiring us to constantly develop our product solutions according to your needs.

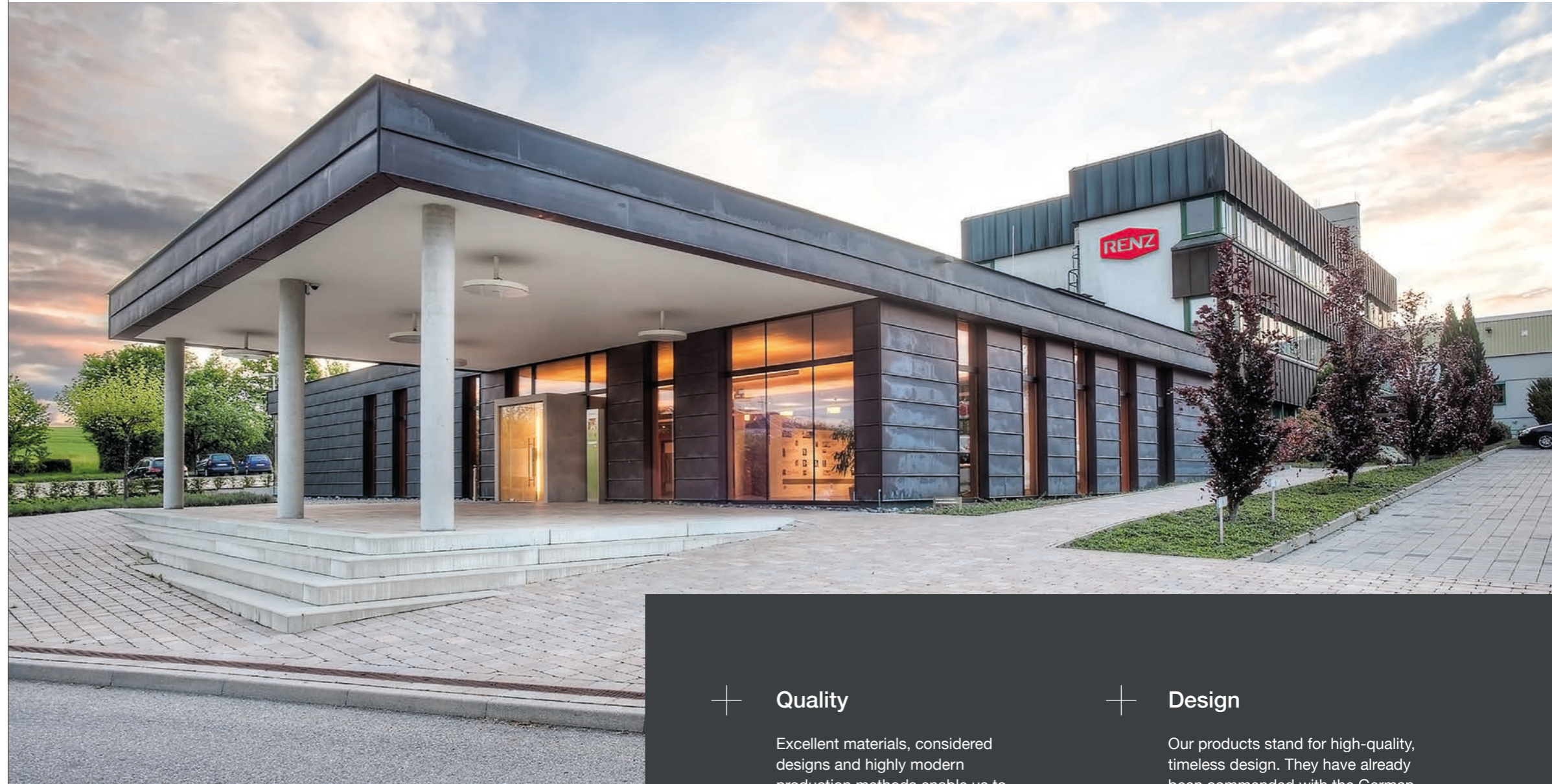

+ Experience since 1925

+ Market leader in Europe

+ Made in Europe

+ Everything from a single source

#### + Quality

Excellent materials, considered designs and highly modern production methods enable us to offer our customers the ultimate in product quality.

#### + Design

Our products stand for high-quality, timeless design. They have already been commended with the German Design Award on multiple occasions.

#### + Sustainability

Constant improvement in product longevity along with eco-friendly production procedures and business processes demonstrate our deep-seated desire to achieve carbon neutrality.

#### + Innovation

We constantly continue to develop our products based on precise market analyses. And we focus on our customers' needs when conducting these analyses.

# Table of contents

Section	Contents	Page
<b>Digital solutions</b>  	Digital concept	10
	Building blocks	12
	Product overview	18
	Mailbox units	20
	Digital notification	23
	Parcel box units	24
	Mail and parcel box units	30
	Control units	34
	Interfaces and integration options	36
	Possible applications	38
<b>Mechanical solutions</b>	Mechanical concept	42
	Orientation	48
	Free-standing	50
	Surface-mounted	62
	Flush-mounted	72
	Door side panel installation	82
	Technical details	92
<b>Individualisation</b>	Colours and surfaces	96
	Intercom / notification systems	98
	High quality extras	100
	Options	101
	Lock types	101
<b>Service</b>	Project support	104
	Software maintenance and support	106



my  
RENZ  
box



# Digital solutions

Digital concept  
 Building blocks  
 Product overview  
 Mailbox units  
 Digital notification  
 Parcel box units  
 Mail and parcel box units  
 Control units  
 Interfaces and integration options  
 Possible applications

my  
RENZ  
box



## myRENZbox – The digital system solution for your building entrance

The smart myRENZbox is far more than merely a mailbox unit. Digitisation begins even before entering due to the system platform for building entrances. This smart mail and parcel box unit is networked with digital notification, a digital nameplate, digital access control and online administration. This enables 24-hour, contactless receipt (and dispatch) of mail, parcels and goods from service providers and neighbours. This streamlines the delivery and administrative processes and reduces CO<sub>2</sub> emissions. The control unit can also be perfectly integrated into an existing ERP or property management system. And digital access to the building and apartment can if desired be combined with the electronic mailbox key to create a one-tag solution. This unusual convenience results in a substantial increase in resident satisfaction – which appreciably enhances the real estate value for property owners, project developers and property managers.

---

+ **Contactless handover platform**

---

+ **Wide range of integration options**

---

+ **Sustainable solution**

---

+ **Enhanced real estate value**

---

## The myRENZbox building blocks

The modular system adopted by Renz ensures that myRENZbox adapts to the individual needs of each property. The individual components – including mailbox, parcel box unit and digital notification – can be optimally combined. The myRENZbox is controlled via a touch display, the myRENZbox app and the myrenz.com portal. Digital nameplates and electronic locks integrate the mailboxes within the smart system. The freely-assignable parcel box compartments in different sizes can even be equipped with a cooling system – for instance for food deliveries. The door station's digital notification operable via the touch screen (with camera and NFC reader on request) provides secure access control.

- + Individually configurable
- + Flexibility due to its modular conception
- + Versatile handover platform
- + Operation via touch display, app and portal
- + Wide range of integration options



Camera



Intercom panel



Touch panel



Digital nameplate



Mailbox



NFC reader



Digital door opener



Digital notification



Parcel box



Cooling compartments





### Mailbox

Our myRENZbox mailbox compartments have an integrated electronic lock for secure opening and closing without the need for a key. A mechanical solution is also available as an option.



### Parcel box

The myRENZbox can be combined with a parcel box unit to create a complete home handover platform. Operation is particularly straightforward thanks to digital integration of the logistics processes used by leading parcel delivery services (DHL, Amazon Logistics, DPD, Hermes and GLS).



### Digital notification

Our myRENZbox digital notification with search function is directly integrated within the system's control unit. The resident's names are clearly listed in alphabetical order on the touch screen. Digital notification also features an optical status indicator.



### Digital door opener

Our myRENZbox enables digital door opening via code or tag (in combination with GIRA, SIEDLE and/or ELCOM).



### NFC reader

An NFC reader enables the integration of customer key tags into the system. This permits digital access to the building and apartment to be combined with the electronic mailbox key to create a one-tag solution.



### Digital nameplate

Digital nameplates give the mail and parcel box unit a modern and smart appearance. The graphics are conveniently added via the **myrenz.com portal**.



### Digital information terminal

The myRENZbox digital information terminal, which also serves as a touch screen for controlling the system, opens up a wide range of possibilities. These include displaying messages or the integration of messaging apps.



### Door station

The myRENZbox door station is equipped with an integrated intercom panel. Camera installation is also possible to enable visual identity checking via video transmission.



### Cooling compartments

Cooling compartments for temperature-sensitive goods are becoming ever more popular. Our myRENZbox cooling compartments, for example, make it possible to deliver fresh food directly to the parcel box unit.

## Optimally networked – for greater convenience and efficiency

### The myRENZbox app

Our app is directly networked with the myRENZbox, thus enabling convenient operation of the mail and parcel box unit from a smartphone and/or tablet. This app is available in iOS and Android versions.

### The myrenz.com portal

The myRENZbox internet portal enables the units to be controlled from the comfort of a property management office. This significantly reduces the administrative burden when there is a tenancy change. Even the residents can make settings via the portal – from amending personal data and creating PIN access codes for the parcel box unit to activating the "No junk mail thanks!" module on the digital nameplate for the mailbox.



So much more than  
a mere mail and  
parcel box unit.  
It's a smart everyday  
assistant that adds  
real value.



## Smart solutions from Renz – Wide-ranging possibilities



### Residential convenience begins at the mailbox

Mailboxes with digital nameplates and electronic locks create added convenience for residents, and appreciably assist with property management.



### Constantly relaxed and secure

Discrete, theft-proof and 24/7 – conveniently receive and return parcels and goods from home.



### One for all

Perfectly coordinated – digital notification and the access control system turn the combined mail and parcel box unit into a digital front door.



## Mailbox units

### User-friendly and permanently aesthetic

Today's convenient living begins with a digital mailbox – especially in an apartment block. Access no longer requires a key, it occurs via app, PIN code or NFC tag. Electronic locks ensure that the ideally secured compartment opens gently and quietly. And our digital nameplate makes illegible labels a thing of the past – which keeps the look clean and modern, even given changes of tenancy.

### Efficient and cost-effective administration

Control of our digital mailbox units occurs fully online, which dispenses with the need to visit the property to change nameplates given a new tenancy. An open API interface means that the administration can simply be integrated within an existing ERP or property management system. This improves the speed of change processes.

- + Digital nameplates
- + Clean and modern look
- + Electronic locks
- + Simple online administration
- + Integration within an ERP system is possible
- + Reduced effort due to digital key management
- + Cost efficiencies thanks to time savings

Mailbox units entirely according to your wishes: select your colour and material. Discover more via our website.



## Mailbox units

### Individual, flexible and tailor-made

Our mailbox units are freely configurable and can be adapted to meet each individual requirement. This even includes production according to special dimensions, flexible equipment of the individual boxes as well as any integration.

Our aim as market leader is to make almost anything possible in terms of equipment and design of our units.

Our customers' wishes are our prime concern: mounting method, material, cladding variants, colour and graphics can be freely selected according to individual desires and sense of style.



Further information on customisation options and service can be found from page 92 onwards.

## Digital notification

### Modern, space-saving and administrator-friendly

The major advantage of Renz digital notification is the massive space saving compared to a conventional doorbell system, alongside the associated cost savings. It is also quick and easy to install at site and requires very little maintenance.



### Complete solution with camera and more

Irrespective of whether the solution is from BUSCH-JAEGER, Comelit, ELCOM, GIRA, Jung, Koch, SIEDLE or TCS: it can all be perfectly integrated into the Renz digital notification's new user interface. So we're already focusing on a complete digital solution in the property sector.

### The myRENZbox enables digital building entry

Digital notification can additionally be integrated into the system for the myRENZbox mail and parcel box units. Use them to create a digital front door that solves the issues of letter reception, parcel reception and dispatch, doorbell and access control.

- + Space-saving solution (no need for a separate doorbell panel)
- + Cost-efficient solution (no need for conventional bell buttons)
- + Low-maintenance
- + Modern look
- + No evidence of empty apartments
- + Find names easily based on alphabetic sorting, character prefix and search function
- + Each residents' name is separately displayed (even in the case of shared apartments)
- + Compliant with data privacy requirements (apartment numbers can be displayed instead of names)
- + Easily legible (even at night) thanks to an illuminated display
- + Optical and acoustic signal for people with a disability and properties subject to loud background noise
- + Simple administration via the myrenz.com portal – no further need for manual replacement of doorbell signs given tenancy changes
- + Scheduling the display, e.g. for short-term rentals
- + Integrable with different door communication systems made by renown manufacturers
- + Different mounting options available
- + Door opening via code or tag (in combination with GIRA, SIEDLE and/or ELCOM)

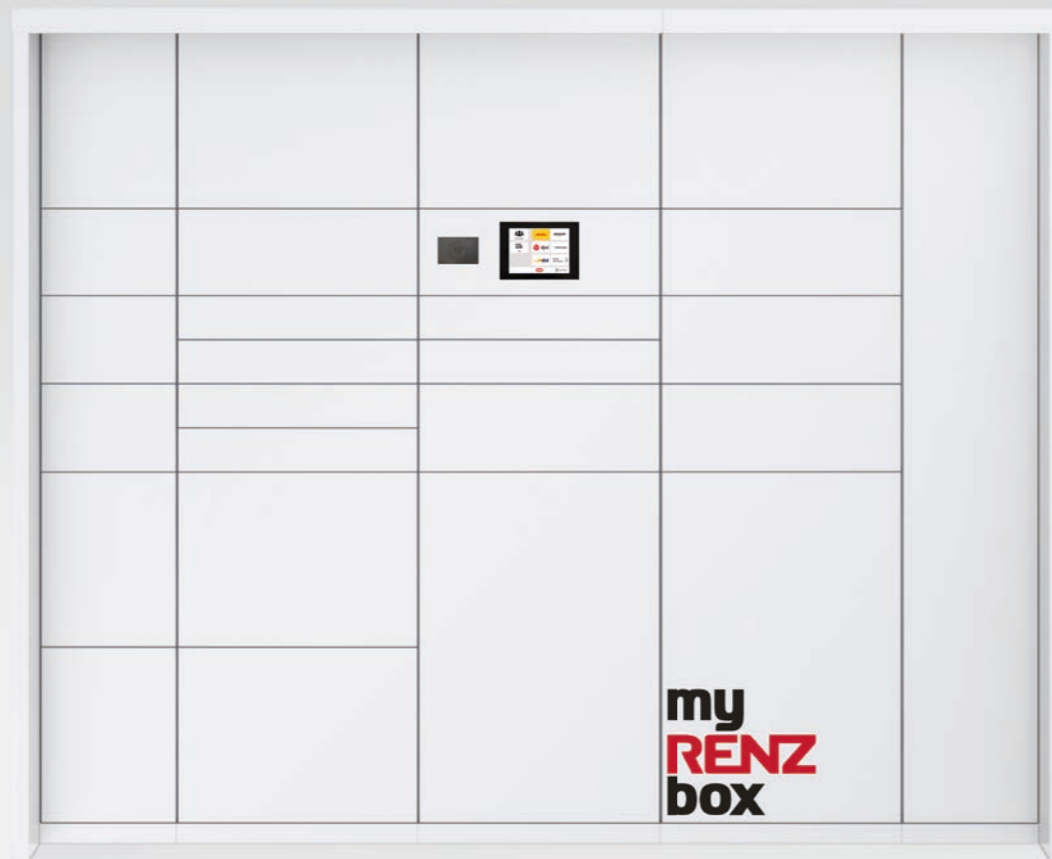

## Parcel box units

### A handover platform for parcels and goods

The constantly growing flood of parcels is making it ever more important to be able to receive and return parcels in a discrete and theft-proof manner – no matter where you happen to be. A smart myRENZbox parcel box unit offers precisely this service. All major parcel delivery services including DHL, Amazon Logistics, DPD, Hermes or GLS deliver around the clock directly to the myRENZbox and also collect parcels there for return. As a digital handover platform – with access options via app, tag or PIN – it's also open to service providers, friends, relatives and neighbours at any time. Administration occurs conveniently online via the myrenz.com portal.

### Genuine time savings that benefit the environment

A myRENZbox parcel box unit permits secure receipt or handover (storage for collection) at any time of the day or night – and right on your doorstep. Parcel deliverers and other service providers only have to drive to the property once, which eliminates failed delivery attempts or the recipient's journey to a parcel collection shop. This not only saves time, it also reduces carbon emissions.

- + Receipt and dispatch 24/7
- + Interfaces to other service providers, neighbours and acquaintances
- + Discrete and secure
- + Authentication via app, tag or PIN
- + Simple online administration
- + Time-saving and sustainable
- + Precisely tailored to every need
- + Flexibly expandable

**Simply explained!**  
Use this link to our video.



**A parcel box unit entirely according to your wishes:**  
discover more via our website.



## Parcel box units

### Modular and flexible in relation to every need

A myRENZbox parcel box unit can be individually adapted to any property size, location and need. The parcel box compartments are aligned to standard parcel sizes (XS, S, M, L, XL). Individual sizes and special equipment, such as clothes rails, cooling compartments and the like can be supplied on request. Indoor and outdoor versions enable installation in any location.

Our parcel box units are the perfect augmentation to apartment blocks that already have a mailbox system. Their modular design with column arrangement and our extension modules make it possible to flexibly vary the number of boxes and how they're equipped. And a simple extension option also retains the greatest possible flexibility for the future.



Further information on customisation options and service can be found from page 94 onwards.

## Modular design: MODULA

### 8.4" control unit



#### Basic module

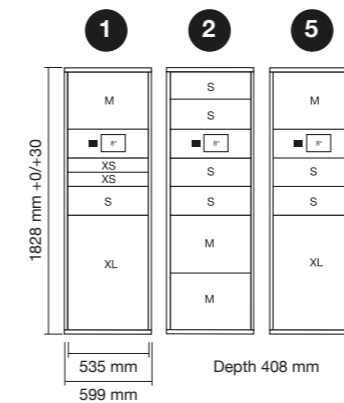

#### Extension modules

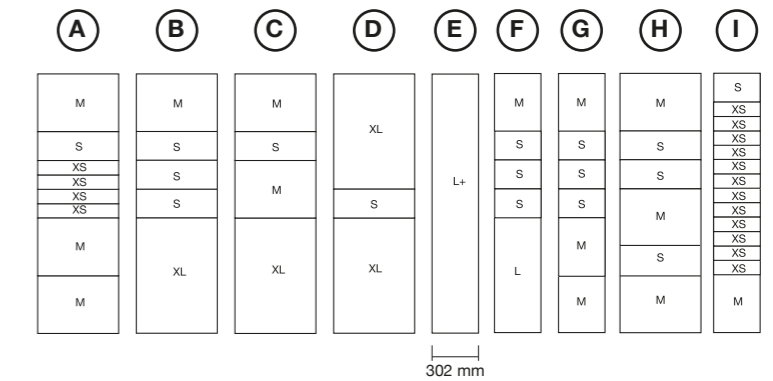

### 3.5" control unit



#### Basic module

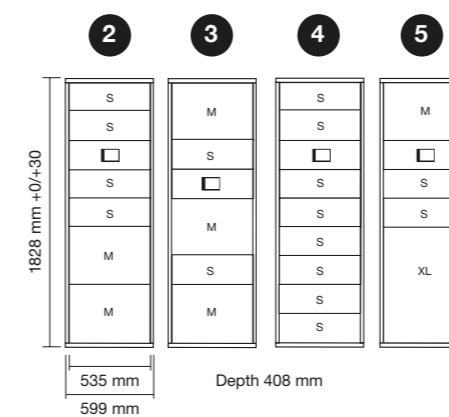

#### Extension modules

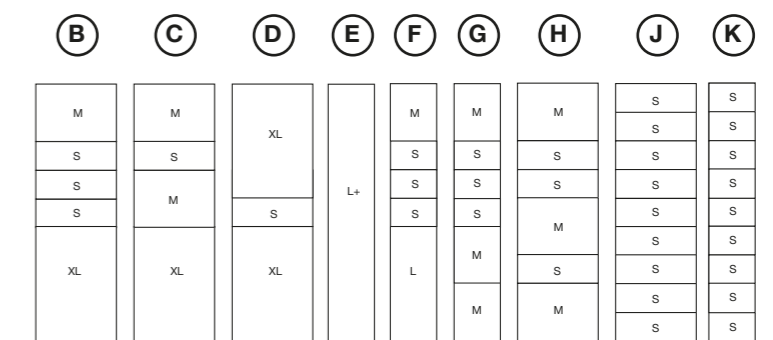

## Modular design: MODULA Extended

### For XXL deliveries

The MODULA Extended system offers you all the benefits of the MODULA range, but the boxes are designed for extra-large deliveries. This range can be supplied with the 8.4" or 3.5" control unit.

8.4" control unit



Basic module:

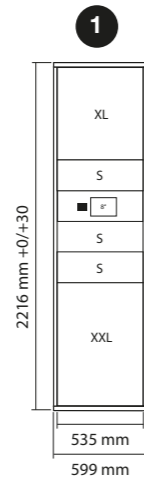

Extension modules:

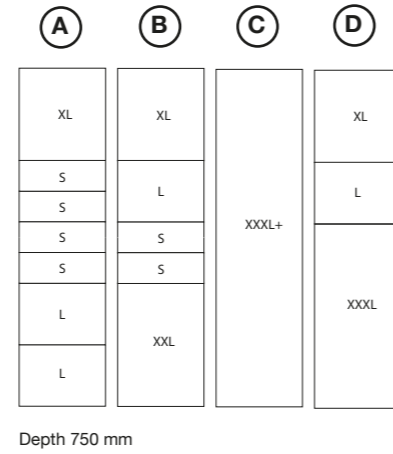

### External dimensions in mm (w x h x d)

Box	Modula 302 mm wide	Modula 535 mm wide	MODULA Extended 535 mm wide
XS	302 x 97 x 408	535 x 97 x 408	–
S	302 x 194 x 408	535 x 194 x 408	535 x 194 x 750
M	302 x 388 x 408	535 x 388 x 408	–
L	302 x 776 x 408	–	535 x 388 x 750
L+	302 x 1746 x 408	–	–
XL	–	535 x 776 x 408	535 x 582 x 750
XXL	–	–	535 x 776 x 750
XXXL	–	–	535 x 1164 x 750
XXXL+	–	–	535 x 2134 x 750

We also offer parcel box units in individual dimensions. Further information can be found from page 32 onwards.





## Mail and parcel box units

### The system solution for a digital front door

A myRENZbox mail and parcel box unit combines the advantages of an electronic mailbox with those of the smart parcel box – and directly on the doorstep. The individual components are perfectly coordinated. Parcel delivery services like DHL, Amazon Logistics, DPD, Hermes or GLS can deliver to the box 24/7 – which avoids the need for additional journeys (and the associated carbon emissions). The unit is even available to service providers or friends, relatives and neighbours for around the clock collections and returns. Access rights are assigned via app, PIN code or NFC tag. Digital access rights to building doors can even be combined with the unit's authentication system to create a one-tag solution. The myRENZbox thus becomes a complete digital solution for entry to the building.

### Online administration and open interfaces

Administration of the unit – including allocation of all resident data and access authorisations – conveniently occurs via the myrenz.com portal, so there is no need for traditional key management. Our digital nameplate and optional digital notification (together with video or audio system) ensure that the appearance remains permanently aesthetic. An open API interface means that the administration can simply be integrated within an existing ERP or property management system. This tightens up the administrative processes. Everyday benefits and cost efficiencies create tangible added value.

- + Digital building entry
- + Receipt and dispatch 24/7
- + Short distances for residents
- + Wide range of integration options
- + Functions are optimally coordinated
- + Simple online administration
- + Reduced effort due to digital key management
- + Saving in carbon emissions
- + Individual design and flexible solutions
- + High cost efficiency and perceptible added value

**Simply explained!**  
Use this link to our video.



**A mail and parcel box unit entirely according to your wishes:**  
discover more via our website.





## Mail and parcel box units

### Tailored and flexible in relation to every need

Its flexible modular capability means that a myRENZbox mail and parcel box unit can be individually adapted to the respective needs, building size and location – both with respect to the number and arrangement of boxes as well as the type of installation, material, equipment and design. This also includes production to special dimensions, flexible equipment of the individual boxes as well as the integration of a variety of options such as third-party modules, cooling boxes, digital nameplates and much more. Indoor and outdoor versions enable installation in any location.

Our central concern is to do almost everything possible to ensure that our customers get what they want. Even cladding colours, foils and engravings can be freely selected according to individual desires and sense of style.

### Combination

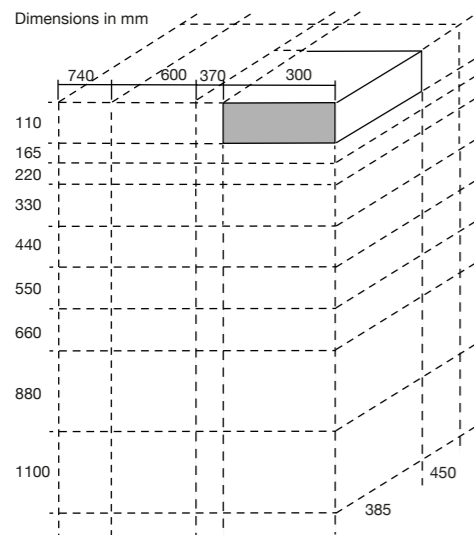

**The modular system of mailboxes, parcel boxes, graphics boxes and installation boxes with many standard dimensions can also be freely combined with individual dimensions – just the way you want it.**

Further information on customisation options and service can be found from page 94 onwards.



## Control units

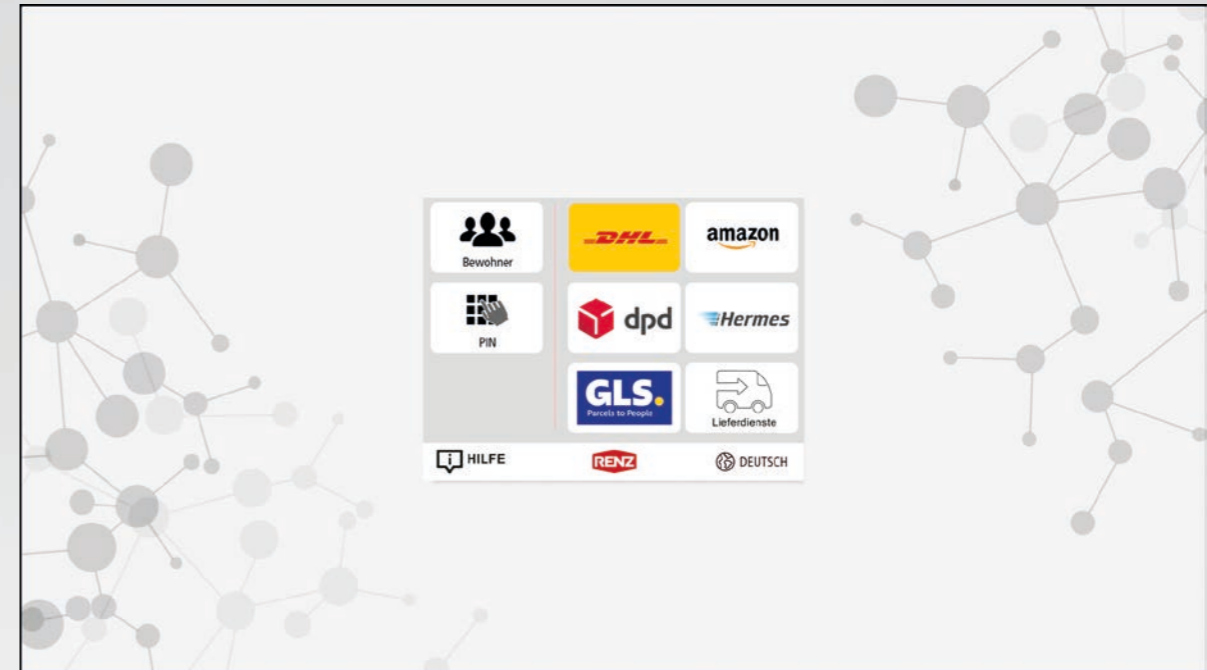
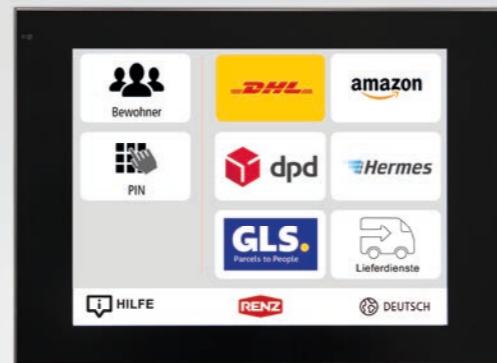

### 3.5" control unit

This control unit features very good legibility, a flush installation and simple operation for all parcel delivery services and deliverers of other goods. The myRENZbox app can be used to quite simply operate and administer the unit. It also has a built-in NFC reader.

### 8.4" control unit

The larger touch display is a central, menu-driven control panel for up to 500-compartment mail and parcel box units. This control unit ensures intuitive operation and easy indoor and outdoor legibility. It integrates flush into the system and the screen design can optionally be customised, with a logo for example. Digital notification can also be integrated.

### 32" control unit

In the case of this touch display, it's not just the screen design that can be individually customised. The display can even serve as a digital information terminal for caretaker messages, or as an advertising display. You determine the content and can even display it on a scheduled basis. Digital notification can also be integrated. The 32" control unit is only designed for indoor use.

### Display size comparison (diagonals)

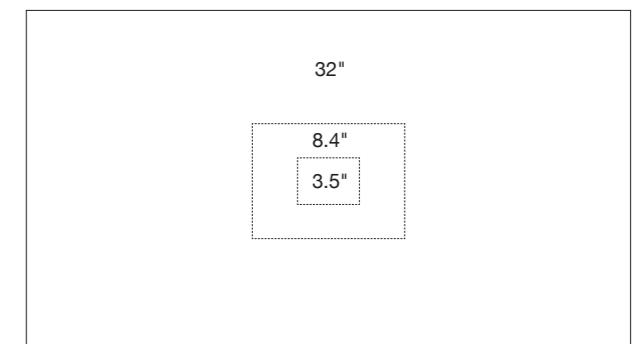

## A wide range of integration options for a complete digital concept

When we think holistically about the digitisation of properties, this does certainly start at the building entrance, but extends far beyond. The coordination and expedient connection of different components and systems is a key prerequisite for smooth operation and optimal user convenience.

Our team's wide-ranging know-how firstly introduces a functional scope that is as extensive as possible and creates maximum flexibility in the processes: our myRENZbox software is thus developed fully in-house. And

we also build on the outstanding expertise of our influential partners. Whether it involves the integration of a doorbell / intercom system (with or without camera), digital access control (such as via NFC), networking with parcel delivery service processes or connecting to existing customer ERP, property management or neighbourhood management systems. Our team's innovative spirit and close collaboration with our partners ensure an ideally coordinated overall digital concept.

Management of residents' and administrators' affairs is kept simple and convenient despite the extensive functional complexity. And regular updates and functional expansion – which naturally take customer requirements into account – are a facet of our broadly based service culture based on decades of experience.

### An overview of our renown partners

#### Access systems



#### Digital notification



#### Neighbourhood management



#### Parcel delivery services



## Advantages for residents, administrators and building owners

The myRENZbox processes form the heart of the system and combine simple, efficient management by administrators with real added value for the residents.



## Diversity in design, functionality and range of application



**Flush-mounted parcel box unit**  
 + Digital parcel box unit  
 + Compact unit for an apartment block



**Door side panel parcel box unit**  
 + Digital parcel box unit  
 + Door side panel installation  
 + Integrated camera  
 + Integrated digital notification

Take an insight into our projects!  
 Learn more about our references.



**Parcel box unit**  
 + Digital parcel box unit  
 + Expandable



**Parcel box unit with individual cladding**  
 + Digital parcel box units  
 + Site-specific individual cladding

## Diversity in design, functionality and range of application



### Neckarbogen Heilbronn

- + Digital mail and parcel box unit with electronic locks
- + Integration into the neighbourhood tenant app
- + 32-inch touch screen – digital notice board
- + One-tag solution: mail and parcel boxes opened via digital key
- + Automation of administrative processes

Take an insight into our projects!  
Learn more about our references.



### Kanalstraße Mainz

- + Digital parcel box unit
- + Compact unit for an apartment block
- + Expandable



### StadtNatur-Architektenhaus Munich-Riem

- + Digital mail and parcel box units
- + Integrated digital notification
- + Digital nameplates
- + Digital key for all registered locks
- + Central digital administration

GLASERSTRASSE 26F



Mechanical concept  
 Orientation  
 Free-standing  
 Surface-mounted  
 Flush-mounted  
 Door side panel installation  
 Technical details

# Mechanical solutions



## Market-leading quality

Highest quality standards and constant innovations – these aspirations in our product philosophy, combined with a high level of service, have earned us the leading position in the German and European mailbox industry. Our success story began in 1925.

Then as now our classics in the mailbox segment are convincing in terms of their design, functionality and production quality. A real testament to the fact that high product quality at a fair price still prevails today.

- + High production quality
- + Sophisticated functionality
- + Convincing design
- + Customer-specific solutions

All things considered, we supply mailboxes for every need and every budget.





## Orientation

Selecting the right mailbox is a question of the installation location, personal taste and the specific budget. Our guidance system is designed to help you find exactly the right mailbox to suit your individual needs.

**Online product finder:**  
you can also discover all our mailboxes via our website.



### Type of installation



**Free-standing** Page 50



**Surface-mounted** Page 62



**Flush-mounted** Page 72



**Door side panel installation** Page 82

Other installation types, such as wall or fence feed-through system, are possible.

### Product categories

#### CLASSIC

Solid workmanship and proven functionality at the best price

#### EXCLUSIVE

Quality and contemporary engineering with a wide range of models

#### PREMIUM

Minimalist design and high-quality detailing for high-end installations

### Product characteristics

#### Unit type:



Mailbox



Parcel box



Combined mail and parcel box units

#### Your type:



Vertical mailboxes



Horizontal mail boxes



Mailboxes with a slope  
Only for door side panel installation from page 82 onwards

#### Material and colour:



Powder-coated in RAL colours



V4A stainless steel



Anodised aluminium

#### Your extra options:



Intercom and doorbell equipment



Second nameplate



Feed-through unit

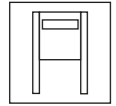

# Free-standing versions

The units depicted can also be supplied with horizontal boxes. You'll find more information on the following pages.

**PREMIUM**



**Commercial Line** \_\_\_\_\_ PAGE 59



**RENZ PLAN** \_\_\_\_\_ PAGE 60



**RENZ PLAN PILLAR / RENZ PLAN S PILLAR** \_\_\_\_\_ PAGE 61

**EXCLUSIVE**



**PRISMA** \_\_\_\_\_ PAGE 54



**QUADRA** \_\_\_\_\_ PAGE 55



**TETRO** \_\_\_\_\_ PAGE 56



**TETRO PILLAR** \_\_\_\_\_ PAGE 57



**RS2000 / RS4000** \_\_\_\_\_ PAGE 58

**CLASSIC**



**BASIC A** \_\_\_\_\_ PAGE 52



**BASIC B** \_\_\_\_\_ PAGE 53

The frames depicted are also available as a version for setting in concrete. Discover more via our website.



Basic A

CLASSIC

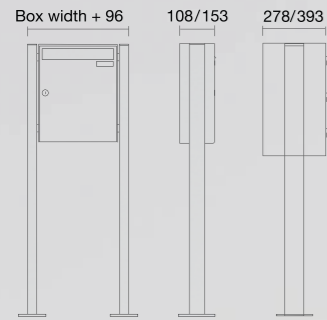

Our standard **BASIC A** cladding is impressive due to its minimalist angular design and favourable price. It is designed for areas requiring rain protection and is optionally available in aluminium or V4A stainless steel. We recommend the timeless rectangular tube stand for this cladding.

Product features at a glance:

- + Cost-effective Renz quality
- + Timeless, minimalist design
- + Cladding made in one piece



Product characteristics



Please see page 98 for the available intercom and notification systems. Other special versions are available on request.

Basic B

CLASSIC

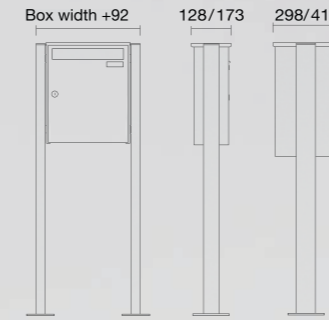

**BASIC B** is a functional cladding at an affordable price. Post is ideally protected against inclement conditions by the projecting rain cover. The cladding is available in Galfan steel, aluminium or V4A stainless steel. We recommend the timeless rectangular tube stand for this cladding.

Product features at a glance:

- + Cost-effective Renz quality
- + Timeless, minimalist design
- + With protruding rain cover



Product characteristics



Please see page 98 for the available intercom and notification systems. Other special versions are available on request.

PRISMA

EXCLUSIVE

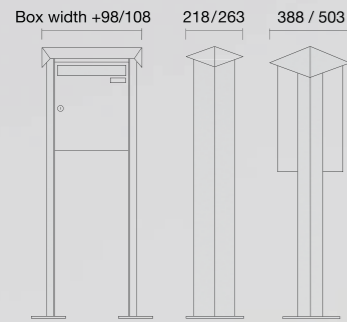

Our **PRISMA** cladding is characterised by its extravagant design and optimal rain protection. Its sloping roof means that dirt can't adhere to it so easily and prevents the likes of waste paper from being discarded there. The PRISMA frame is perfectly coordinated with the cladding. This cladding can be supplied in Galfan steel or V4A stainless steel.

- Product features at a glance:**
- + Ideal rain protection
  - + Self-cleaning roof shape
  - + Sloping roof prevents waste being discarded
  - + Extravagant design
  - + Cladding and frame from one cast



Product characteristics

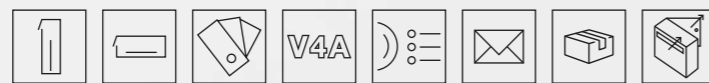

Please see page 98 for the available intercom and notification systems. Other special versions are available on request.

QUADRA

EXCLUSIVE

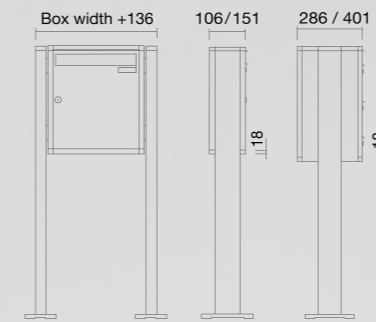

The high quality workmanship of our **QUADRA** cladding provides a modern, angular design. Equipped with an integrated rain deflector, so ideal for outdoor use. The 3- or 4-sided cladding is made from a surrounding aluminium profile. It can be supplied with a colour powder coating or anodised. We recommend the rectangular tube stand for this cladding.

- Product features at a glance:**
- + Modern, angular design
  - + Integrated rain deflector
  - + Can be supplied as a 3- or 4-sided cladding (only in the case of vertical boxes)
  - + Distinctive shadow gap



Product characteristics



Please see page 98 for the available intercom and notification systems. Other special versions are available on request.

### TETRO

EXCLUSIVE

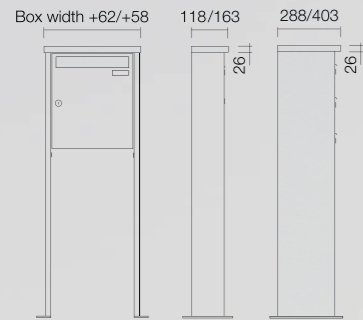

Straight forms and a modern look are special features of our **TETRO** cladding. Various roof shapes are available, including our straight roof with projection for optimal rain protection (with integrated LED lighting on request). The cladding and frame are perfectly coordinated. **TETRO** can be supplied in Galfan steel or V4A stainless steel.

**Product features at a glance:**

- + Modern, linear design
- + LED lighting can be integrated within the roof projection
- + Available with different roof shapes

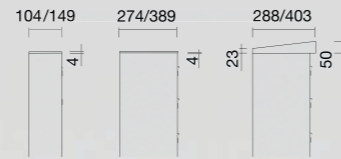

**Product characteristics**

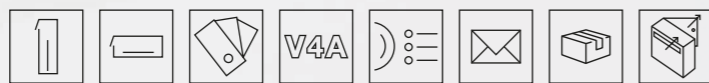

Please see page 98 for the available intercom and notification systems. Other special versions are available on request.

### TETRO PILLAR

EXCLUSIVE

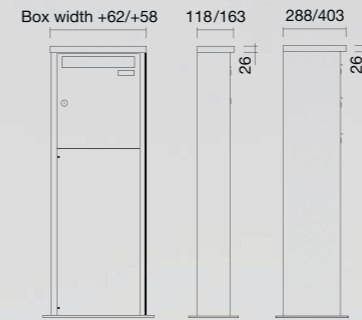

Straight forms and a modern look are special features of our **TETRO PILLAR** cladding. Various roof shapes are available, including our straight roof with projection for optimal rain protection (with integrated LED lighting on request). The cladding and frame are perfectly coordinated. **TETRO PILLAR** can be supplied in Galfan steel or V4A stainless steel.

**Product features at a glance:**

- + Modern, linear design
- + LED lighting can be integrated within the roof projection
- + Available with different roof shapes

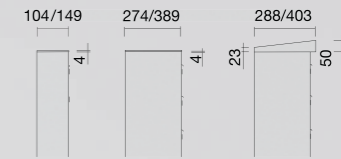

**Product characteristics**

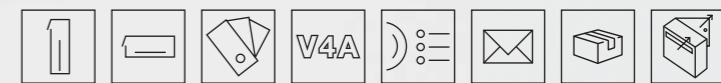

Please see page 98 for the available intercom and notification systems. Other special versions are available on request.

RS2000/RS4000

EXCLUSIVE

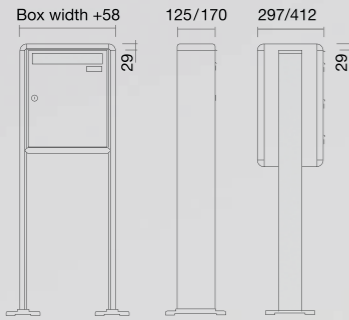

Our **RS2000/RS4000** cladding is extremely stable and features a friendly, rounded design. The sturdy, circumferential aluminium profile is supplied in colour powder coating or anodised. A rain deflector is also available on request. We recommend the perfectly matching **RS2000** frame or the oval tube stand for this cladding.

Product features at a glance:

- + Superbly sturdy quality
- + Friendly, rounded design
- + Cladding and frame from one cast (RS2000)
- + Stable, self-supporting aluminium profile (RS2000)
- + Can be supplied with a rain deflector on request



Product characteristics



Please see page 98 for the available intercom and notification systems. Other special versions are available on request.

Commercial line

PREMIUM

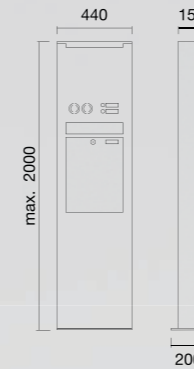

**Commercial line** is a range of high quality mailbox pillars. It is ideal for a commercial setting or the upmarket private sector. In addition to LED lighting, almost all third-party modules and individual extras can be integrated. Renz **Commercial line** pillars are optionally available in Galvan steel or V4A stainless steel.

Product features at a glance:

- + Representative design
- + Flush integrated mailbox
- + Large size for a high mail volume
- + Easy to install, since the column door can be opened via two locks and swung open
- + Pre-wired
- + Ground piece available for setting in concrete



Product characteristics



Please see page 98 for the available intercom and notification systems. Other special versions are available on request.

## RENZ PLAN

PREMIUM

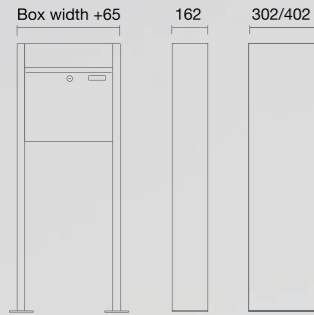

Linear but with soft detailing: our range of **RENZ PLAN** units. A minimalist design, flat surfaces and flush mail flaps make this high-quality range a real design highlight that also impresses due to its perfect technology and unique quality. **RENZ PLAN** can be optionally supplied in Galfan steel or V4A stainless steel.

- Product features at a glance:**
- + Totally flush design
  - + Adjustable insertion system with lockable insertion flap (for vertical boxes)
  - + Large mail volume
  - + Noise-reduced mail flap
  - + RSA2 nameplate as standard equipment
  - + Door hinge selectable (tilt door or hinged door for vertical boxes)
  - + Spacious mailboxes
  - + Synchronous flap mechanism on 165 mm high horizontal boxes for easy mail removal



### Product characteristics

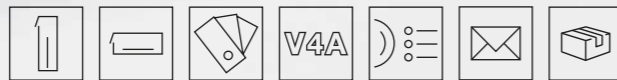

Please see page 98 for the available intercom and notification systems. Other special versions are available on request.

## RENZ PLAN PILLAR/ RENZ PLAN S PILLAR

PREMIUM



Our **RENZ PLAN PILLAR** in proven design or the exclusive **RENZ PLAN S PILLAR**. Its flush design with laser-cut edges, minimal gap dimensions and harmonious proportions alongside extra-thick V4A stainless steel distinguish our **RENZ PLAN S** range.

- Product features at a glance:**
- + Totally flush design
  - + Adjustable insertion system with lockable flap
  - + Large mail volume
  - + Noise-reduced mail flap
  - + RSA2 nameplate as standard equipment
  - + Extra-thick material
  - + Tilt door with opening restrictor
  - + Installation box with concealed lock
  - + Distinguished with the German Design Award



### Product characteristics



Please see page 98 for the available intercom and notification systems. Other special versions are available on request.

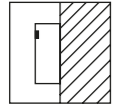

# Surface-mounted versions

The units depicted can also be supplied with horizontal boxes. You'll find more information on the following pages.

**PREMIUM**



**RENZ PLAN** \_\_\_\_\_ PAGE 70    **RENZ PLAN S** \_\_\_\_\_ PAGE 71

**EXCLUSIVE**



**PRISMA** \_\_\_\_\_ PAGE 66



**QUADRA** \_\_\_\_\_ PAGE 67



**TETRO** \_\_\_\_\_ PAGE 68



**RS2000/  
RS4000** \_\_\_\_\_ PAGE 69

**CLASSIC**



**BASIC A** \_\_\_\_\_ PAGE 64



**BASIC B** \_\_\_\_\_ PAGE 65



Basic A

CLASSIC

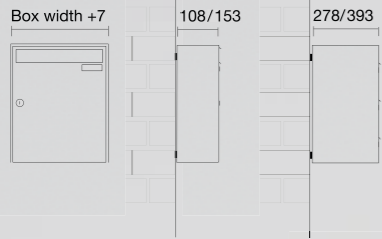

Our standard **BASIC A** cladding is impressive due to its minimalist angular design and favourable price. It is designed for areas requiring rain protection and is optionally available in aluminium or V4A stainless steel.

Product features at a glance:

- + Cost-effective Renz quality
- + Timeless, minimalist design
- + Cladding made in one piece



Product characteristics

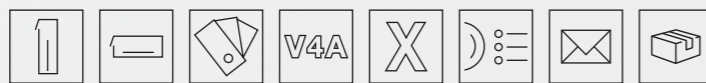

Please see page 98 for the available intercom and notification systems. Other special versions are available on request.

Basic B

CLASSIC



**BASIC B** is a functional cladding at an affordable price. Post is ideally protected against inclement conditions by the projecting rain cover. The cladding is available in Galfan steel, aluminium or V4A stainless steel.

Product features at a glance:

- + Cost-effective Renz quality
- + Timeless, minimalist design
- + With protruding rain cover



Product characteristics

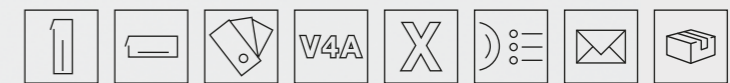

Please see page 98 for the available intercom and notification systems. Other special versions are available on request.

PRISMA

EXCLUSIVE

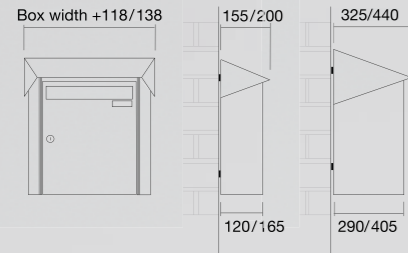

Our **PRISMA** cladding is characterised by its extravagant design and optimal rain protection. Its sloping roof means that dirt can't adhere to it so easily and prevents the likes of waste paper from being discarded there. This cladding can be optionally supplied in Galvan steel or V4A stainless steel.

Product features at a glance:

- + Ideal rain protection
- + Self-cleaning roof shape
- + Sloping roof prevents waste being discarded
- + Extravagant design



Product characteristics



Please see page 98 for the available intercom and notification systems. Other special versions are available on request.

QUADRA

EXCLUSIVE

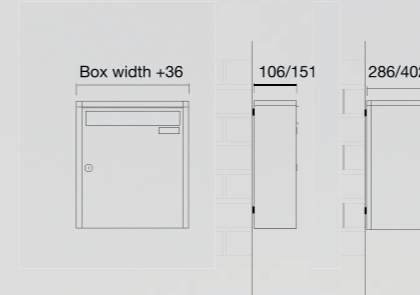

The high quality workmanship of our **QUADRA** cladding provides a modern, angular design. Equipped with an integrated rain deflector, so ideal for outdoor use. The 3- or 4-sided cladding is made from a surrounding aluminium profile. It can be supplied with a colour powder coating or anodised.

Product features at a glance:

- + Modern, angular design
- + Integrated rain deflector
- + Available as 3- or 4-sided cladding
- + Distinctive shadow gap



Product characteristics



Please see page 98 for the available intercom and notification systems. Other special versions are available on request.

TETRO

EXCLUSIVE

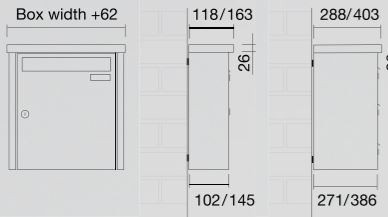

Straight forms and a modern look are special features of our **TETRO** cladding. Two roof shapes are available, including our straight roof with projection for optimal rain protection (with integrated LED lighting on request). The cladding and frame are perfectly coordinated. **TETRO** can be supplied in Galvan steel or V4A stainless steel.

- Product features at a glance:**
- + Modern, linear design
  - + LED lighting can be integrated
  - + Two roof shapes available



Product characteristics



Please see page 98 for the available intercom and notification systems. Other special versions are available on request.

RS2000/RS4000

EXCLUSIVE

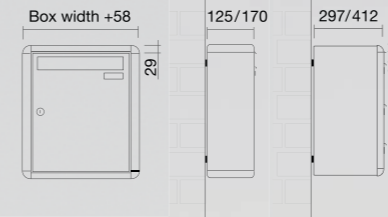

Our **RS2000/RS4000** cladding is extremely stable and features a friendly, rounded design. The sturdy, circumferential aluminium profile is supplied in colour powder coating or anodised. A rain deflector is also available on request.

- Product features at a glance:**
- + Friendly, rounded design
  - + Stable, self-supporting aluminium profile
  - + Superbly sturdy quality
  - + Can be supplied with a rain deflector on request



Product characteristics



Please see page 98 for the available intercom and notification systems. Other special versions are available on request.

## RENZ PLAN

PREMIUM

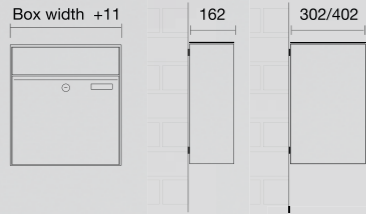

Linear but with soft detailing: our range of **RENZ PLAN** units. A minimalist design, flat surfaces and flush mail flaps make this high-quality cladding a real design highlight that also impresses due to its perfect technology and unique quality. This stylish cladding can be optionally supplied in Galfan steel or V4A stainless steel.

### Product features at a glance:

- + Totally flush design
- + Adjustable insertion system with lockable flap
- + Large mail volume
- + Noise-reduced mail flap
- + RSA2 nameplate as standard equipment
- + Door hinge selectable (tilt door or swing door)
- + Synchronous flap mechanism on 165 mm high horizontal boxes for easy mail removal



### Product characteristics

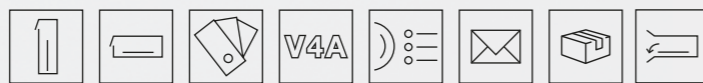

Please see page 98 for the available intercom and notification systems. Other special versions are available on request.

## RENZ PLAN S

PREMIUM

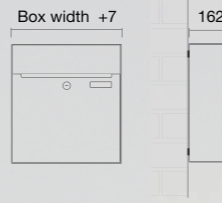

Precision in solid design: this aptly describes our exclusive **RENZ PLAN S** range. Its flush design with perfect edges, minimal gap dimensions and harmonious proportions along with the extra-thick V4A stainless steel make this superior cladding something very special.

### Product features at a glance:

- + Precise workmanship
- + Totally flush design
- + Extra-thick material
- + Adjustable insertion system with lockable flap
- + Large mail volume
- + Noise-reduced mail flap
- + RSA2 nameplate as standard equipment
- + Tilt door with opening restrictor
- + Installation box with concealed lock
- + Distinguished with the German Design Award



### Product characteristics

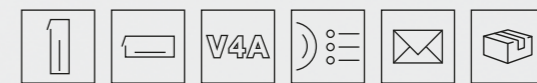

Please see page 98 for the available intercom and notification systems. Other special versions are available on request.

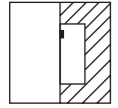

# Flush-mounted versions

The units depicted can also be supplied with horizontal boxes. You'll find more information on the following pages.

**PREMIUM**



**RENZ PLAN** \_\_\_\_\_ PAGE 78

**RENZ PLAN S** \_\_\_\_\_ PAGE 79

**EXCLUSIVE**



**PRISMA** \_\_\_\_\_ PAGE 75



**SHADOW  
GAP FRAME** \_\_\_\_\_ PAGE 76



**RS3000/  
RS3100** \_\_\_\_\_ PAGE 77

**CLASSIC**



**BASIC** \_\_\_\_\_ PAGE 74

**BASIC**

**CLASSIC**

Box width +40/80/50

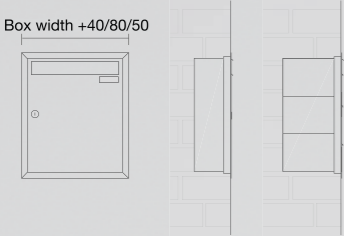

Our standard **BASIC A** cladding is impressive due to its minimalist angular design and favourable price. It generously covers the wall recess and thus ensures a clean look. It is optionally available in aluminium or V4A stainless steel. A rain deflector is available as an option.

- Product features at a glance:**
- + Cost-effective Renz quality
  - + Aluminium frame width 20 and 40 mm, stainless steel 25 mm
  - + Flush finish with the wall
  - + Can be supplied with a rain deflector on request



**Product characteristics**

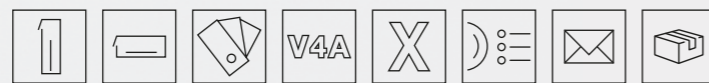

Please see page 98 for the available intercom and notification systems. Other special versions are available on request.

**PRISMA**

**EXCLUSIVE**

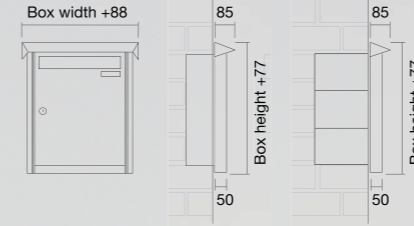

Our **PRISMA** plaster cover frame is characterised by its extravagant design and optimal rain protection. A sloping roof means that dirt can't adhere too easily. Can be supplied in Galfan steel or V4A stainless steel.

- Product features at a glance:**
- + Extravagant design
  - + Ideal rain protection
  - + Self-cleaning roof shape
  - + Low installation depth



**Product characteristics**



Please see page 98 for the available intercom and notification systems. Other special versions are available on request.

### SHADOW GAP FRAME

EXCLUSIVE

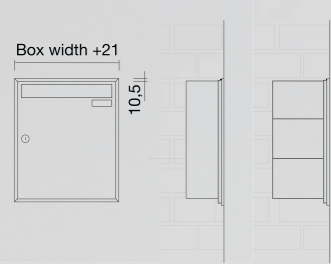

Our **SHADOW GAP FRAME** is designed for precise installation and an elegant appearance. It encloses the mailbox flush with the plaster and has a uniform circumferential shadow gap (8 mm). This flush-mounted frame is made of aluminium and can optionally be colour powder-coated or anodised.

**Product features at a glance:**

- + Flush-mounted
- + Narrow design
- + Modern, elegant look



**Product characteristics**



Please see page 98 for the available intercom and notification systems. Other special versions are available on request.

### RS3000/RS3100

EXCLUSIVE

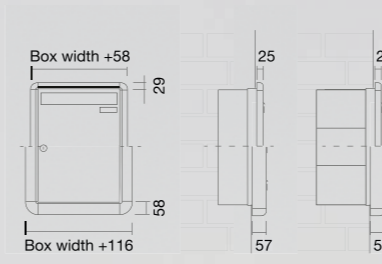

**RS3000** and **RS3100** are extremely stable plaster cover frames with a friendly, rounded design. Both aluminium profiles are very sturdy and can be supplied with a colour powder coating or anodised. A rain deflector is also available on request.

**Product features at a glance:**

- + Friendly, rounded design
- + Available in two versions
- + Zinc die-cast corners
- + Sturdy hollow-chamber profile
- + Can be supplied with a rain deflector on request



**Product characteristics**



Please see page 98 for the available intercom and notification systems. Other special versions are available on request.

## RENZ PLAN

PREMIUM

Installation options  
can be found on page 80

Linear but with soft detailing:  
our range of **RENZ PLAN** units.  
A minimalist design, flat surfaces  
and flush mail flaps make this  
high-quality flush-mounted frame  
a real design highlight that also  
impresses due to its perfect  
technology and unique quality.  
Can be optionally supplied in  
Galvan steel or V4A stainless steel.

**Product features at a glance:**

- + Totally flush design
- + Adjustable insertion system  
with lockable flap (only for  
vertical boxes)
- + Large mail volume
- + Noise-reduced mail flap
- + RSA2 nameplate as standard  
equipment
- + Door hinge freely selectable  
(tilt door or swing door)
- + Synchronous flap mechanism  
on 165 mm high horizontal  
boxes for easy mail removal

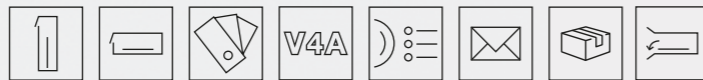
**Product characteristics**

Please see page 98 for the available intercom and notification systems.  
Other special versions are available on request.

## RENZ PLAN S

PREMIUM

Installation options  
can be found on page 80

Precision in solid design: this  
aptly describes our exclusive  
**RENZ PLAN S** range. Its flush  
design with perfect edges, minimal  
gap dimension and harmonious  
proportions along with the extra-  
thick V4A stainless steel make  
this superior flush-mounted frame  
something very special.

**Product features at a glance:**

- + Precise workmanship
- + Totally flush design
- + Extra-thick material
- + Adjustable insertion system  
with lockable flap
- + Large mail volume
- + Noise-reduced mail flap
- + RSA2 nameplate as standard  
equipment
- + Tilt door with opening restrictor
- + Installation box with concealed  
lock
- + Also available in PVD-coated  
brushed stainless steel (brass  
effect)
- + Distinguished with the German  
Design Award

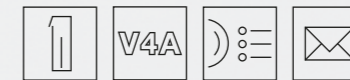
**Product characteristics**

Please see page 98 for the available intercom and notification systems.  
Other special versions are available on request.



RENZ PLAN and RENZ PLAN S installation options

Classic installation with angular plaster cover frame



Flush-mounted installation with tight-fitting cladding

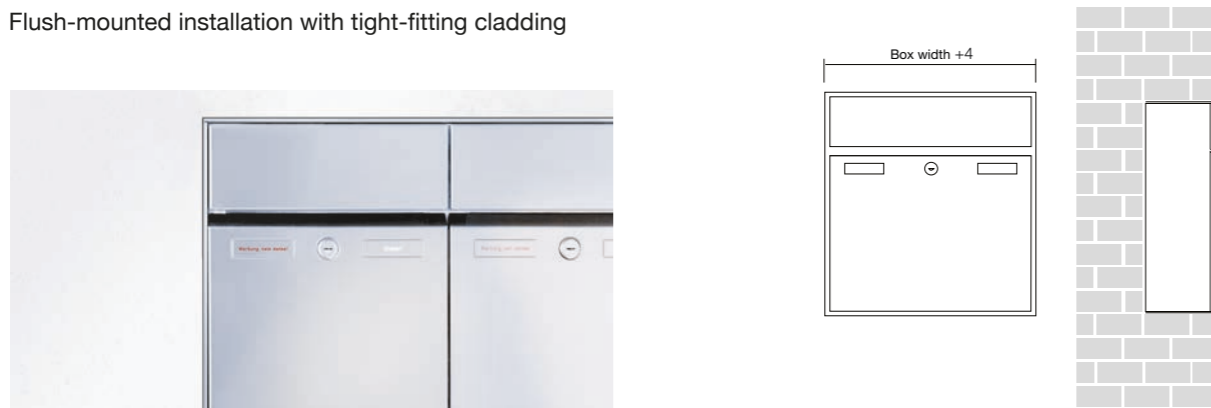

Installation with a shadow gap (ideal for curtain walling)

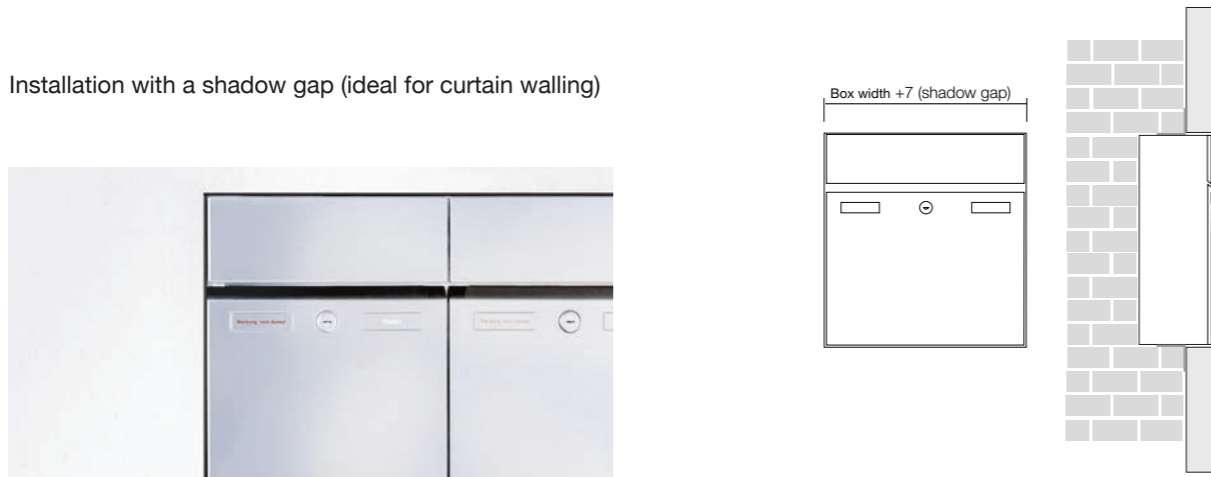

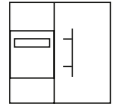

# Door side panel installation versions

The units depicted can also be supplied with horizontal boxes. You'll find more information on the following pages.

**PREMIUM** ❄️❄️❄️



**RENZ PLAN S DOOR PROFILE INSTALLATION**  
(24-72 MM) \_\_\_\_\_ PAGE 90



**RENZ PLAN S GLASS INSTALLATION**  
(24-72 MM) \_\_\_\_\_ PAGE 90



**RENZ PLAN S SASH-COVERING**  
(24-72 MM) \_\_\_\_\_ PAGE 90

**EXCLUSIVE** ❄️❄️



**INSULATED FRONT DOOR PROFILE INSTALLATION**  
(28-72 MM) \_\_\_\_\_ PAGE 88



**INSULATED FRONT SASH-COVERING**  
(35 MM) \_\_\_\_\_ PAGE 88

**CLASSIC** ❄️



**UNINSULATED FRONT DOOR PROFILE INSTALLATION**  
(2/2.5/24 MM) \_\_\_\_\_ PAGE 86



**INSULATED FRONT DOOR PROFILE INSTALLATION**  
(24 MM) \_\_\_\_\_ PAGE 86

## Insulation – protection against heat loss

A mailbox in the door side panel is simply convenient: there's no need to go outside, just conveniently collect the post from inside. There is conversely the risk of draughts and heat loss. So good insulation in the door side panel is therefore just as important as in the door itself. We offer you various options depending on budget.

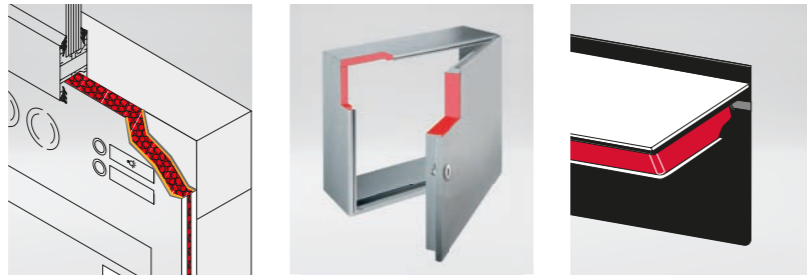

Insulated front panel  
(24–72 mm)

Insulated mailbox housing

Insulated mail flap

### CLASSIC



Provides basic protection. The insulated front panel significantly reduces heat loss to the outside compared to an uninsulated front panel. The mailbox housing and mail flap are not insulated.

### EXCLUSIVE



Provides very good protection due to an insulated front panel and, on request, a fully insulated mailbox housing. The mail flap is not insulated. The U-value of the test unit with an insulated mailbox is  $0.59 \text{ W}/(\text{m}^2\text{K})^*$ .

### PREMIUM



Provides the best protection against heat loss and draughts. Here, in addition to the fully insulated front panel, even the mail flap is insulated and, on request, the complete mailbox housing. The U-value of the test unit with an insulated mailbox is  $0.54 \text{ W}/(\text{m}^2\text{K})^*$ .



Note on condensation water according to expert opinion: even in the case of units with thermal separation of the front panel and insulated boxes, the occurrence of condensation cannot be completely ruled out under certain climatic conditions. Many physical variables mean that this effect can occur in isolated cases, especially in heated entrance areas. Regular ventilation helps to prevent condensation because it can reduce humidity levels.

## Burglar-resistant RC2 security

We commissioned the renowned ift test institute in Rosenheim to test our mailbox units with respect to RC2 security in line with DIN EN 1627. You can therefore even apply to KfW for funding regarding burglary protection measures (you can find information on current funding schemes via the KfW website).

### Embossed fronts

The fronts and mail flaps on Renz mailbox units are embossed, not punched. This not only results in a visual improvement, but also provides greater stability and better protection against corrosion.

Further information on door side panel installation can be found here.



## Well prepared for the EnEV (German Energy Saving Ordinance)

Door side panel mailbox units from Renz were certified as having the best U-values. Extensive tests at the ift test institute in Rosenheim resulted in our test units achieving outstanding U-values:

**U-value\* up to  $0.54 \text{ W}/(\text{m}^2\text{K})$**

**Renz does not just state a general U-value, because this would be incorrect.** The U-value also changes, of course, given the various configuration options for a mailbox unit. Renz therefore calculates the U-value for each unit individually based on a specific formula.

### \*Individual U-value determination

Extensive U-value tests were conducted on our door side panel mailbox units in collaboration with the ift test institute in Rosenheim. These are not theoretical calculations, but actual measurements conducted using different mailbox models.

We can use the numerous measurement results available to derive a U-value for individually configured mailbox units, which is then to be understood as an approximate value. This U-value is calculated for each installation and is shown on quotations and order confirmations.

## Down-to-earth quality

Do you mainly value solid workmanship and proven functions? Then our RENZ CLASSIC is just the thing for you. The impressive feature here is its insulated front panel, which

reduces heat losses to the outside. The mail flap is made from lightweight and rustproof aluminium and the nameplate and doorbell system are very easy to label.



### Product characteristics



Please see page 98 for the available intercom and notification systems. Other special versions are available on request.

### UNINSULATED FRONT DOOR PROFILE INSTALLATION (2 / 2.5 / 24 MM)

Mailbox front for a door side panel without insulation for unheated entrances (thickness: 24 mm). Available in Galfan steel or V4A stainless steel.

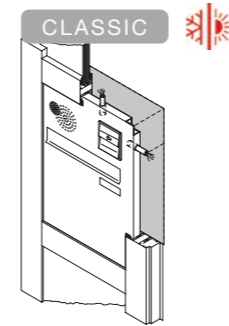

#### Product features at a glance:

- + Cost-effective solution
- + Sturdy, embossed mail flap with withdrawal guards
- + Non-visible cable routing
- + Full projection 24 mm thick
- + Connection cable optionally pre-laid

### INSULATED FRONT DOOR PROFILE INSTALLATION (24 MM)

Door side panel front with full surface insulation (thickness: 24 mm). Available in Galfan steel, aluminium or V4A stainless steel.

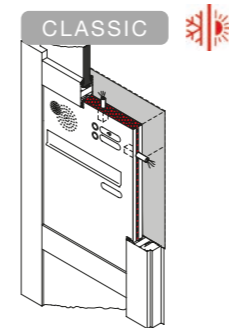

#### Product features at a glance:

- + U-value up to 0.58 W/(m²K)
- + Full surface, single-piece front insulation
- + Sturdy, embossed mail flap with withdrawal guards
- + Box block can be detached for easy assembly
- + Non-visible cable routing
- + Separate material / colour choice for front and back
- + Connection cable optionally pre-laid

## A wide variety of options

Our RENZ EXCLUSIVE gives you a wide range of options. Select an insulated mailbox that protects against draughts and add a Renz RSK flap for virtually inaudible mail

delivery. We can offer two versions in terms of your doorbell system: modern or classic. You decide in each case based on quality and the latest technology.



### Product characteristics



Please see page 98 for the available intercom and notification systems. Other special versions are available on request.

### INSULATED FRONT DOOR PROFILE INSTALLATION (28–72 MM)

Door side panel front with full surface insulation (thickness: 24–72 mm, in increments of 4 mm). Available in Galvan steel, aluminium or V4A stainless steel.

EXCLUSIVE

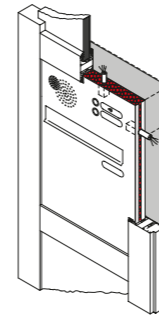

### INSULATED FRONT SASH-COVERING (35 MM)

Sash-covering front with full surface insulation (thickness: 35 mm). Available in aluminium or V4A stainless steel.

EXCLUSIVE

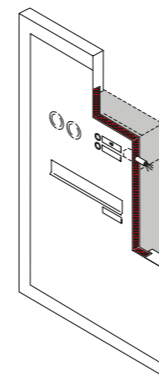

#### Product features at a glance:

- + U-value up to 0.58 W/(m<sup>2</sup>K)
- + Full surface, single-piece front insulation
- + Can be supplied in a thickness of up to 72 mm
- + Sturdy, embossed mail flap with withdrawal guards
- + Box block can be detached for easy assembly
- + Non-visible cable routing
- + Separate material / colour choice for front and back
- + Connection cable optionally pre-laid

#### Product features at a glance:

- + Front flush-mounted with door profile
- + Full surface, single-piece front insulation
- + Sturdy, embossed mail flap with withdrawal guards
- + Deep-drawn withdrawal guards
- + Non-visible cable routing
- + Separate colour choice for front and back
- + Connection cable optionally pre-laid

## RENZ PLAN S – Precision in solid design

The innovative range of mailboxes for the door side panel is called RENZ PLAN S. It has a uniquely high quality alongside its minimalist design with its absolutely flat

surface and extremely precise edges. The front panel is made of a perceptibly solid material, either in powder coated steel or anodised aluminium.



### Product characteristics

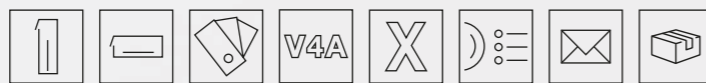

Please see page 98 for the available intercom and notification systems. Other special versions are available on request.

### RENZ PLAN S DOOR PROFILE INSTALLATION (24–72 MM)

PREMIUM

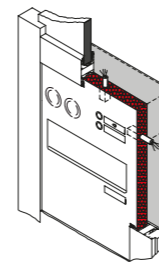

Precision in solid design: this aptly describes our exclusive **RENZ PLAN S** range.

In addition to a flush design with perfect edges and minimal gap dimensions, it's the solid quality of the Galfan steel or V4A stainless steel that make this door side panel front something very special. It can be supplied in a thickness of 24–72 mm (in increments of 6 mm).

#### Product features at a glance:

- + Best U-values thanks to outstanding insulation
- + Full surface, single-piece front insulation
- + Insulated and muted mail flap with magnetic stops, all-round draught seal
- + Flush mail flap with non-retraction strip
- + Connection cable optionally pre-laid
- + Distinguished with the German Design Award

### RENZ PLAN S GLASS INSTALLATION (24–72 MM)

PREMIUM

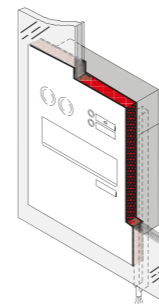

Precision in solid design: this aptly describes our exclusive **RENZ PLAN S** range.

In addition to its flush design with perfect edges and minimal gap dimensions, it is the solid quality of the Galfan steel or V4A stainless steel that make this door side panel front something very special. Frameless integration into the glass pane has an extremely elegant appeal. The front can be supplied in a thickness of 24–72 mm (in increments of 6 mm).

#### Product features at a glance:

- + Frameless integration into the glass pane
- + Best U-values thanks to outstanding insulation
- + Full surface, single-piece front insulation
- + Insulated and muted mail flap with magnetic stops, all-round draught seal
- + Flush mail flap with non-retraction strip
- + Distinguished with the German Design Award

### RENZ PLAN S SASH-COVERING (24–72 MM)

PREMIUM

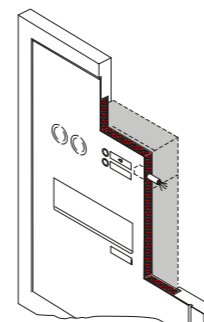

Precision in solid design: this aptly describes our exclusive **RENZ PLAN S** range.

In addition to its flush design with perfect edges and minimal gap dimensions, it's the solid quality of the Galfan steel or V4A stainless steel that make this door side panel front something very special. It can be supplied in a thickness of 24–72 mm (in increments of 6 mm).

#### Product features at a glance:

- + Front is integrated flush with the door profile
- + Best U-values thanks to outstanding insulation
- + Full surface, single-piece front insulation
- + Insulated and muted mail flap with magnetic stops, all-round draught seal
- + Flush mail flap with non-retraction strip
- + Connection cable optionally pre-laid
- + Distinguished with the German Design Award

## Technical data for free-standing, surface-mounted, flush-mounted installations



### Vertical mailboxes

Box width	Box height	Box depth	Litres	DIN EN 13724	Classic	Exclusive	Premium Commercial line	Premium RENZ PLAN
260	330	100	8		x	x		
260	440	100	11	x	x	x		
260	440	145	16	x	x	x		
300	440	100	13	x	x	x		
300	440	145	19	x	x	x		
370	330	100	12	x	x	x		
370	330	145	17	x	x	x		
370	440	100	16	x	x	x		
370	440	145	23	x	x	x		
335	550	140	20	x			x	
335	770	140	30	x			x	
300	440	160	21	x				x
400	440	160	28	x				x



### Horizontal mail boxes

Box width	Box height	Box depth	Litres	DIN EN 13724	Classic	Exclusive	Premium RENZ PLAN
260	110	385	11	x	x	x	
260	220	385	22	x	x	x	
260	330	385	32	x	x	x	
300	110	385	12	x	x	x	
300	165	385	19	x	x	x	
300	220	385	25	x	x	x	
300	330	385	37	x	x	x	
370	110	270	11	x	x	x	
370	165	270	16	x	x	x	
370	220	270	21	x	x	x	
370	330	270	32	x	x	x	
320	165	400	20	x			x
320	330	400	40	x			x
420	165	300	20	x			x
420	330	300	40	x			x

## Technical data for door side panel installations



### Vertical mailboxes

Box width	Box height	Box depth	Litres	Insulated mailbox	DIN EN 13724	Classic	Exclusive	Premium
260	330	100	8			x	x	
300	330	100	10			x	x	
300	440	145	19		x	x	x	
370	330	100	12		x	x	x	
370	330	145	17		x	x	x	
370	440	145	23		x	x	x	x
300	440	145	12	x	x	x	x	
370	330	145	11	x	x	x	x	
370	440	145	15	x	x	x	x	x



### Horizontal mail boxes

Box width	Box height	Box depth	Litres	Insulated mailbox	DIN EN 13724	Classic	Exclusive	Premium
260	110	385	11		x	x	x	
260	220	385	22		x	x	x	
260	330	385	32		x	x	x	
300	110	385	12		x	x	x	
300	165	385	19		x	x	x	
300	220	385	25		x	x	x	
300	330	385	37		x	x	x	
370	110	270	11		x	x	x	
370	165	270	16		x	x	x	
370	220	270	21		x	x	x	x
370	330	270	32		x	x	x	x
300	165	385	12	x	x	x	x	
300	220	385	17	x	x	x	x	
300	330	385	27	x	x	x	x	
370	165	270	10	x	x	x	x	
370	220	270	15	x	x	x	x	x
370	330	270	23	x	x	x	x	x



### Inclined mailboxes

Box width	Box height	Box depth	Litres	Insulated mailbox	DIN EN 13724	Classic	Exclusive	Premium
260	110	300	8		x	x	x	
260	220	300	17		x	x	x	
260	330	300	25		x	x	x	
260	110/330	300	16		x	x	x	
300	110	300	10		x	x	x	
300	220	300	19		x	x	x	
300	330	300	29		x	x	x	
300	110/330	300	19		x	x	x	

Some special sizes, deviating equipment variants and material combinations may also be possible on special request.



# Individualisation

Colours and surfaces  
Intercom / notification systems  
High quality extras  
Options  
Lock types



## Colours and surfaces

### An individual look and feel

Each property has its own unique character. Maintaining a stylish, holistic appearance makes it important to also be in a position to visually customise mail and parcel box units. We therefore don't compromise when it comes to selecting material and colours.

Our units are produced using high quality Galfan steel, aluminium or V4A stainless steel. Powder coating in many different colours or brushed V4A stainless steel are available as finishes. Over 200 colours,

most of which are taken from the RAL colour register, lend each of our mail and parcel box units a very individual look and feel.

Brushed V4A stainless steel with a PVD coating in a brass effect is a particular highlight. We offer this for smaller units, individual flaps and small doorbell panels. The RSA2 intercom/ doorbell system is also available in PVD. There is also an option to use modern wooden cladding (see image on page 44).

### Colours and finish

- + **Over 200 RAL colours** to select from
- + **Two standard colours** available
- + **Colours not included in the RAL 841-GL colour register** may be possible on request
- + **Application of colour powder provided by the customer** may be possible on request



The colours shown should not be considered as binding.

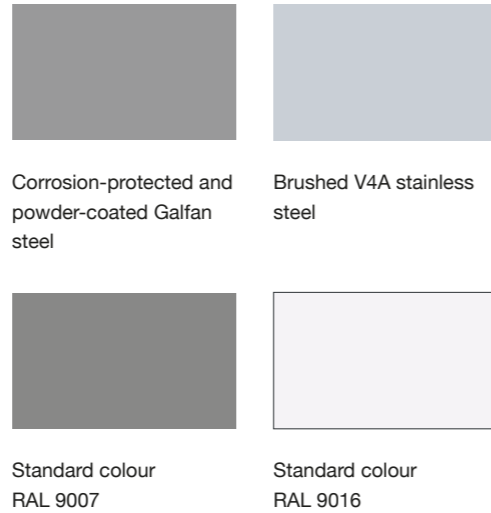

A RAL colour fan can be found here:



## Labelling and LED lighting

All our mail and parcel box units – whether mechanical or digital – enjoy almost unlimited labelling options on all available materials. Some can also be supplied with various versions of LED backlighting.

We offer LED lighting in different versions and configurations.

- + **Engravings:** Lettering milled into the material and with a special coating – very long service life
- + **Through-engravings:** Material completely milled through and cast flush with the surface using casting resin – can be illuminated via LED
- + **Foil lettering:** Inexpensive lettering
- + **Digital printing:** Ideal portrayal of colour logos, photos and emblems
- + **Screen printing:** Perfect for large quantities
- + **Film decals:** In an individual design



LED lighting



LED background lighting



Engraving



Through-engraving

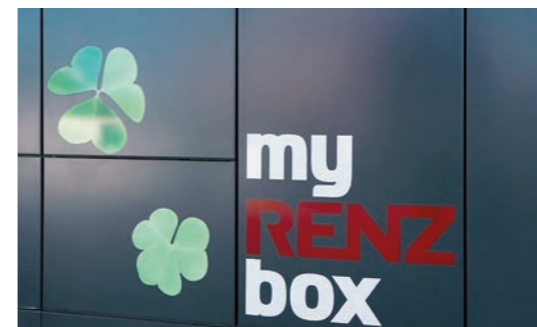

Film decals



Screen printing

# Intercom / notification systems

## Individual or system solution

Our notification systems can also be integrated within our mail and parcel boxes. RSA1 is particularly protected against vandalism due to its design, RSA2 has a modern look and flush finish in addition to this protection.

## Audio and video combined

A good intercom / notification system is now part of the basic equipment of many modern mailbox systems. The additional integration of modules such as a camera, fingerprint scanner or code keypad turns the mailbox into a versatile device on your doorstep. In this respect we cooperate with renowned manufacturers like Gira, Siedle, Busch-Jaeger, Comelit, ELCOM, TCS and many others.

**CLASSIC**

Intercom panel plastic module\*  
Doorbell plastic module\*



**EXCLUSIVE**

Intercom panel RSA1 standard  
Doorbell RSA1

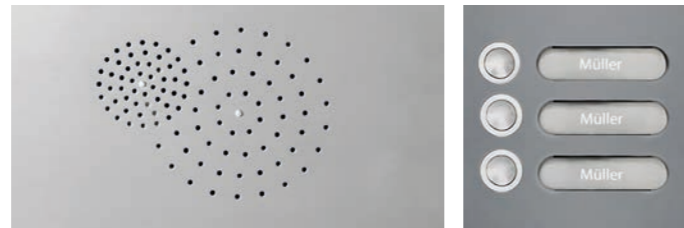

Intercom panel RSA2 standard  
Doorbell RSA2 compact

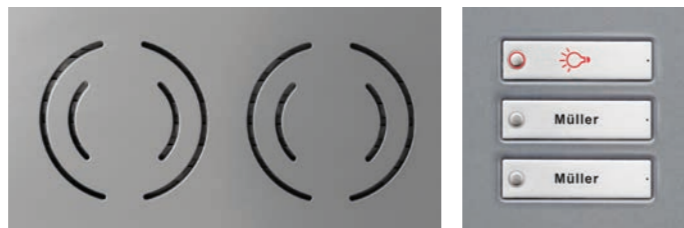

**PREMIUM**

Intercom panel RSA2 standard  
Doorbell RSA2

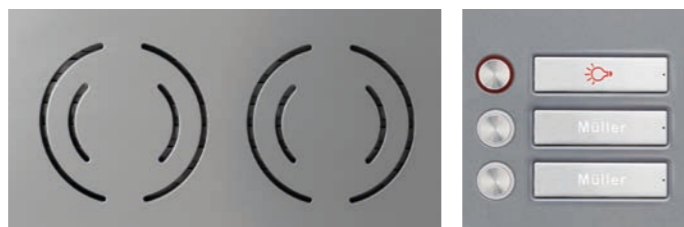

\* Intercom panel plastic modules and doorbell plastic modules with flush optics will be available from the end of 2023

# Product line comparison

	CLASSIC	EXCLUSIVE	PREMIUM	
Notification system/ intercom panels	Plastic module	RSA1	RSA2 compact	RSA2
Illuminated metal nameplate	-	●	○	○
Illuminated plastic nameplate	●	●	●	●
Flush name plate	●	●	●	●
Completely flush design	-	-	-	●
Nameplate replaceable from the front	●	-	●	●
Nameplate replaceable using special tool supplied	-	-	●	●
Plastic version	●	●	●	●
Metal version	-	●	○	○
Doorbell/ nameplate separated	-	●	-	●
Illuminated doorbell button	●	-	●	●
LED lighting	●	●	●	●
Anti-vandalism version	-	●	●	●
Pre-wired connections	-	●	-	-
Tactile buttons (mechanically perceptible button pressure)	-	-	●	●
Bus suitability	●	●	●	●
Size of the insert for plastic version	60 x 15 mm	60 x 15 mm	59 x 13.6 mm	65 x 13.6 mm
Loudspeaker adapter can be clipped off for mounting	●	●	●	●
Quick-clamp fastening for loudspeaker	●	-	●	●
Puncture-proof speech fields due to adapter	●	-	●	●
Laser cut or perforated speech fields	○	●	●	●
Design variants	1	1	4	4

● standard ○ optional - not available

### Alternative RSA2 speech fields

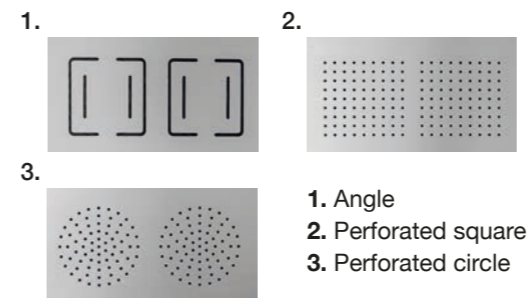

### Examples of third party modules



Our devices in the mailbox units allow you the flexibility to select the third-party module device that suits you best.

## High quality extras



### RSK Renz unit mail flap

- + Dampers for gentle, barely audible closure
- + Built-in spring that keeps the mail flap tightly closed, prevents annoying rattling in windy conditions (no staircase noise)
- + Integrated rain deflection system for mail that is always dry
- + Standard in the case of stainless steel models, at extra cost in the case of powder-coated models



### Renz insertion barrier

- + Specifically for empty apartments and during holidays
- + Tear-resistant special film for secure closure
- + Very cost-effective solution
- + Invisible when the mail flap is closed
- + Suitable for all standard mail flaps, adjustable to the width
- + Easy installation from the outside, eminently suitable for masonry mailboxes
- + Easy to remove
- + Patented system



### RS50 inclined mail opening

- + Even your bulky weekend newspaper fits into the mailbox via the RS50 inclined mail opening
- + A guide panel and two sturdy, serrated withdrawal guards prevent unauthorised access
- + The RS50 inclined mail opening can be supplied at extra cost for mailboxes from 300 mm width and 145 mm depth



### Second nameplate

Consider an optional second nameplate with "No advertising please!" or "Advertising, yes please!" or "No advertising or free newspapers" to help declutter your mailbox.



### Flush mail flap

Our flush mail flap has an integrated nameplate with plenty of labelling space, a flap damper and a closing spring. It will be available from the end of 2023.

## Options



**Combination code lock** made of black metal; the lock is disengaged after input of the 3-digit code



**Code lock**  
Black, battery-operated code lock with a 4-digit code that can be set directly on the lock



Cut-out and assembly for **lever cylinder** supplied by the customer



### 2- and 3-point locking

- + RENZ PLAN 2-point locking: Standard on horizontal mailboxes
- + 2- and 3-point- locking can be supplied for many models



### Door hinge

- + CLASSIC and EXCLUSIVE: door hinged on left as per DIN
- + RENZ PLAN vertical: door hinged on right as per DIN, or on left instead of a tilt door

## Parcel box locks



### Mechanical locks

#### Features

- + Customary opening using a key
- + Price-oriented solution
- + Self-locking

#### Possible lock types

- + Comfort parcel box lock
- + Comfort Plus parcel box lock



### Electronic locks

#### Features

- + Opening via PIN, tag or app
- + Clean and modern look
- + One-tag solution (one key for mailbox, front door, etc.)
- + Protection against theft and vandalism (no surface for attack)
- + If the key is lost, the only requirement is for reprogramming rather than replacement of the locking system

#### Possible lock types

- + RENZ mail and parcel box lock



# Service

Project support  
Software maintenance  
and support

## The service we provide to you



### Project planning

A large network of office and field staff, specialist dealers and other sales partners is there to assist you during your planning and realisation. Location, installation method, budget as well as potential sustainability and logistics concepts are accordingly taken into account. Comprehensive consulting and training services are part of our service offering – whether it involves new construction, conversion or extension of a property.



### Planning assistance

We provide helpful tips and tricks in terms of planning, placement and installation to ensure that your mail and parcel box unit is integrated precisely into the overall concept for a property. Our customers also enjoy utmost planning certainty due to our detailed offers with dimensioned drawing. We also provide a dxf-drawing as part of our offer for use within the planning programme.



### Installation, commissioning and maintenance

Detailed installation and care instructions in relation to our mail and parcel units are also available. Installation instructions can already be viewed from the quotation or order confirmation stage; these are individually matched to the equipment in the configured system to ensure smooth installation. Customers can also access our replacement part service long after the unit has been commissioned.

Further information and guidance can be found via our website.











# Software maintenance and support

## Securing operation, promoting longevity – our Renz software maintenance

We have added software maintenance to our comprehensive range of services to ensure that our customers enjoy their myRENZbox mail and parcel box units for a long time. Our multi-member development team is constantly developing innovative features

and providing new functions, even in the context of new customer requirements. Concluding a software maintenance agreement means that our customers can always benefit from these innovations.

### Your advantages at a glance

-  Easy administration of the unit via myrenz.com for administrators, operators, residents, employees or users
-  Notification via email, push or SMS (optional)
-  Ongoing improvements in performance, ergonomics and ease of use
-  All updates and further developments of the standard software, app and portal are included
-  The latest patches for a high level of security and stability
-  Parcels are directly insured for up to 1,000 euros per claim
-  Adaptation of the software to technical and functional requirements as well as statutory provisions (including GDPR)
-  Connectivity between the unit, the myrenz.com portal and the app ensures secure data exchange

Hotline and remote service for questions and faults.

**Monday – Friday, 07:00 – 17:00**  
**Email: [service@renzgroup.de](mailto:service@renzgroup.de)**  
**Phone: +49 (0) 71 44 / 88 675 - 50**

## Quick and direct access to solutions – Renz maintenance agreements

Your myRENZbox hardware will remain with you for a long time thanks to its optimum quality and the conclusion of a maintenance agreement. This enables us to achieve the longevity of your

myRENZbox and a rational use of resources. You can select between a standard agreement and a premium agreement when it comes to maintenance.

### Standard

- + Annual functional test of the mechanical myRENZbox wear parts and electronics according to the service plan
- + Including working time and travel expenses
- + Documentation of the service work performed
- + Discount on the replacement of mechanical wear parts and electronics based on a quotation, as well as 15% on hardware and 10% on services

### Premium

- + Replacement of defective mechanical wear parts and electronics (not in the case of natural disasters or vandalism)
- + Preparation of a quotation for other repairs (e.g. in the case of vandalism or natural disasters)
- + Cost reliability due to a fixed annual amount

**Take advantage of our comprehensive services and opt for the right package for you!**



## **Erwin Renz Metallwarenfabrik GmbH & Co KG**

Boschstraße 3, 71737 Kirchberg/Murr, Germany  
Phone +49 (0) 71 44 / 301 - 0, Fax +49 (0) 71 44 / 301 - 4444  
Email: [info@renzgroup.de](mailto:info@renzgroup.de), Online shop: [shop.renzgroup.de](http://shop.renzgroup.de)  
[www.renzgroup.com](http://www.renzgroup.com)

Colour deviations are possible.

We reserve the right to make technical changes. Figures sometimes show non-standard equipment.

The generic masculine is used to improve readability of the text.

This is however intended to refer to all gender identities.